

Operating Instructions – Vaccon VDS-1000 Solid State Combination Vacuum Switch/Sensor w/ Digital Display

The VDS-1000 combines either two (2) low voltage, high side or low side, switched outputs and one (1) analog transducer output with a 3-digit LED digital display.

Installation

The VDS-1000 has two 1/8” NPT sensing ports for ease of connection. The unused port must be plugged for proper operation. The wiring diagram below shows the proper input/output connections. Note: All ground connections should be common to the source to reduce the opportunity for short or open circuits, or erroneous readings caused by peripheral noise.

See the separate section for alternate mounting configurations.

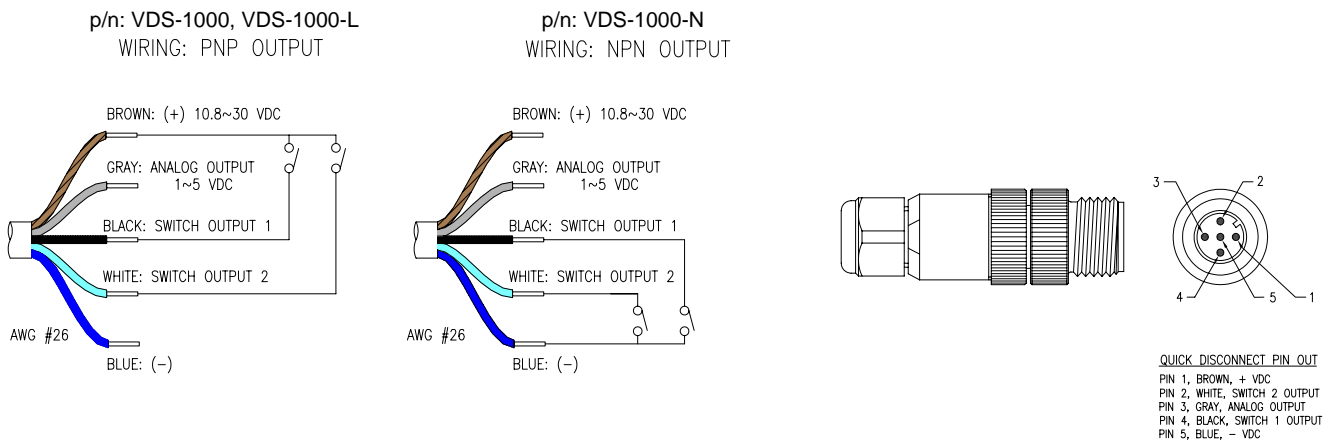

Figure 1

Installation Notes

- Maximum pressure allowed at the VDS 1000 for a vacuum break is 500kPa (72.5 PSI).
- For stability, use a regulated DC power supply.
- With inductive loads, use surge absorbing diodes or varistors. If using a switching power supply, the FG terminal should be earthed. Do not run wires parallel to high tension cables or power lines.
- DO NOT crimp cable or wires during handling.
- DO NOT put any pressure on the body of the sensor when tightening fitting.
- DO NOT use pointed objects such as pens to press the setting buttons.
- USE pH neutral detergent to clean the body. DO NOT use solvents such as thinners.
- DO NOT use for the detection of flammable gases.
- Protect fittings from damage to ensure good seals.
- Enclosure is dust proof and drip proof (to IP65 IEC standards) and is not suitable for environments requiring higher standards.
- When analog output is supplied to a noise-sensitive device use a low-pass filter in the line.
- DO NOT insert any object into the vacuum/pressure port, as it will damage the internal diaphragm and cause the VDS-1000 to malfunction.

Specifications

Dimension

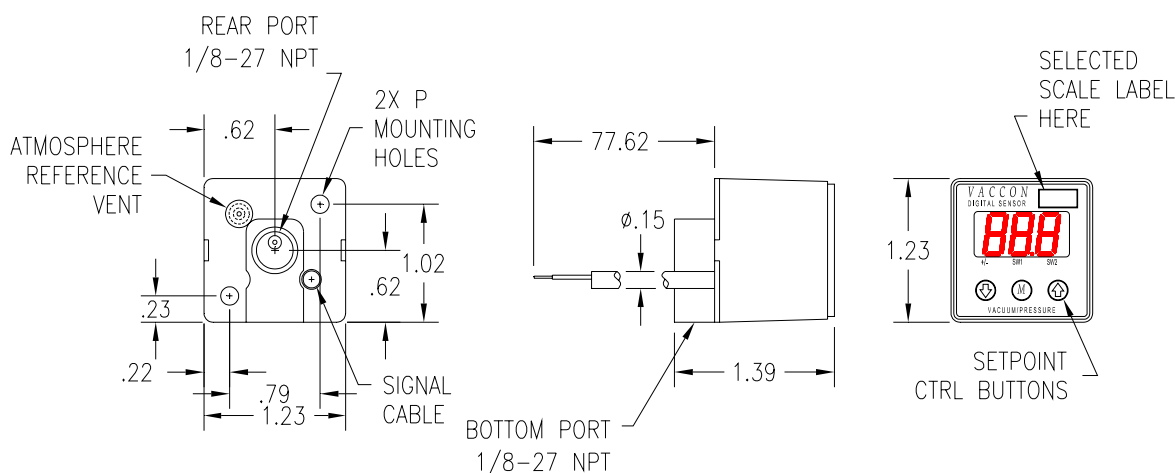

Performance

Specification	VDS-1000	VDS-1000-N	VDS-1000-L
Rated Vacuum Range	-14.5 to 14.5 PSI (-982 mbar to 1 bar)		-1.5 to 1.5 PSI (-101.5 mbar to .10 bar)
Proof Pressure	29 PSI (2 bar)		2.9 PSI (.20 bar)
Burst Pressure	72.5 PSI (5 bar)		7.25 PSI (.50 bar)
Media	Non-Corrosive, Dry Gases		
Supply Voltage	10.8 to 30 VDC		
Current Consumption	70 mA Max		
Switch Type	Transistor Open Collector		
Sensing/Switching Material	Single Crystal Silicon		
Outputs	(2) PNP Switched, (1) 1-5 VDC Analog	(2) NPN Switched, (1) 1-5 VDC Analog	(2) PNP Switched, (1) 1-5 VDC Analog
Electrical Connection	5-Wire -26 AWG - 7'(2m), Optional 5 Pin, M12 Quick Disconnect		
Hysteresis	Adjustable - 0 to 300 Digit		
Repeatability	+/- 0.2% Full Scale, 1 Digit		
Response Time	5 ms Max		
Circuit Protection	Exists		
Max. Switched Voltage Load	30 VDC		
Max. Switched Current Load	100 mA		
Thermal Error	+/- 3% Full Scale/ 121°F (50°C)		
Thermal Compensation	NONE		
Display	Full 3 Digit LED (sampling rate: 4/sec)		
Switch Indication	SW1–Green LED ON (Switched Output ON) SW2–Red LED ON (Switched Output ON)		
IP Protection	IP65		
Operating Temperature	15°F to 125°F (-10°C to 52°C)		
Operating Humidity	35 to 85% RH (No Condensation)		
Construction	ABS/ Aluminum Die-Cast/ Buna		
Fitting/Connection	2 - 1/8" NPT (Female) - Back and Bottom		
Net Weight	3.7 oz. (105g)		
Safety and Environmental Compliance	CE, RohS		

VDS 1000 Initial Setup

STEP 1 - Calibration

- Press both arrow buttons simultaneously for more than one second to calibrate/zero the unit to atmospheric pressure.
- Display will show **0ad**.
- Release buttons when the display flashes.
- The VDS 1000 is now calibrated/zeroed to atmosphere.

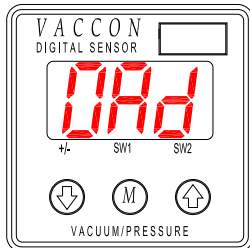

STEP 2 - Selecting the Scale

- Press the down arrow and the mode button simultaneously to enter the scale mode.
- Using the down and up arrow buttons set the 3rd digit to the appropriate scale factor (SEE TABLE 1).
- Once desired setting is selected press the mode button to move to the 2nd digit.
- SW1 LED will be flashing.

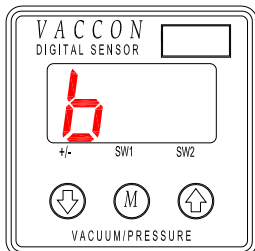

Table 1 – Display Scale

3 rd Digit	Scale	Range
1	kPa	-99.9 – 99.9
2	n/a	
3	kgf/cm2	-999 - 999
4	mmHg	-750 - 750
6	n/a	
7	mbar	-999 - 999
8	psi	-14.5 – 14.5
b	"Hg	-29.5 – 29.5

STEP 3 - Select the Analog Output Mode

- *Skip this step if NOT using ANALOG outputs.*
- The LED under SW1 should be flashing.
- If LED is not flashing press the mode button until LED is illuminated.
- Using the down and up arrow buttons set the 2nd digit to the desired analog output mode (SEE TABLE 2).
- Once desired setting is selected press the mode button to move to the 1st digit.

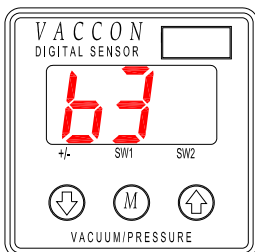

Table 2 – Analog Output Modes

Display	Mode Types	Range		
		-Pr	0	+Pr
1	R mode	1vdc	1vdc	5vdc
2	G mode	1vdc	1vdc	5vdc
3	V mode	5vdc	1vdc	1vdc

STEP 4 - Select the Switch Output Mode

- The LED under SW2 should be flashing.
- If LED is not flashing press the mode button until LED is illuminated.
- Using the down and up arrow buttons set the 1st digit to the desired switch output mode (SEE TABLE 3). Tables 4 and 5, on page 4, provide additional detailed information on the *Switch Output Modes*.

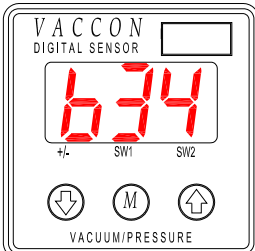

Table 3 – Switch Output Modes

Output	SW1 OUTPUT				SW2 OUTPUT			
	Separate		Window Comparator		Separate		Window Comparator	
Mode	HI	LO	A	B	HI	LO	A	B
1	<input type="checkbox"/>				<input type="checkbox"/>			
2	<input type="checkbox"/>					<input type="checkbox"/>		
3		<input type="checkbox"/>			<input type="checkbox"/>			
4		<input type="checkbox"/>				<input type="checkbox"/>		
5			<input type="checkbox"/>				<input type="checkbox"/>	
6			<input type="checkbox"/>				<input type="checkbox"/>	<input type="checkbox"/>
7				<input type="checkbox"/>			<input type="checkbox"/>	
8				<input type="checkbox"/>			<input type="checkbox"/>	<input type="checkbox"/>
Pressure Setting (Operating Point)	Setting 1		(Lower Limit) : Setting 1 (Upper Limit) : Setting 2		Setting 2		(Lower Limit) : Setting 1 (Upper Limit) : Setting 2	

STEP 5 - Return to Operation Mode

- Once desired setting is selected press the mode button for more than one second to return to the operation mode.

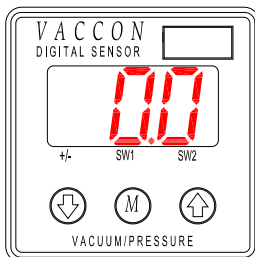

Table 4 – Programmable Output Modes

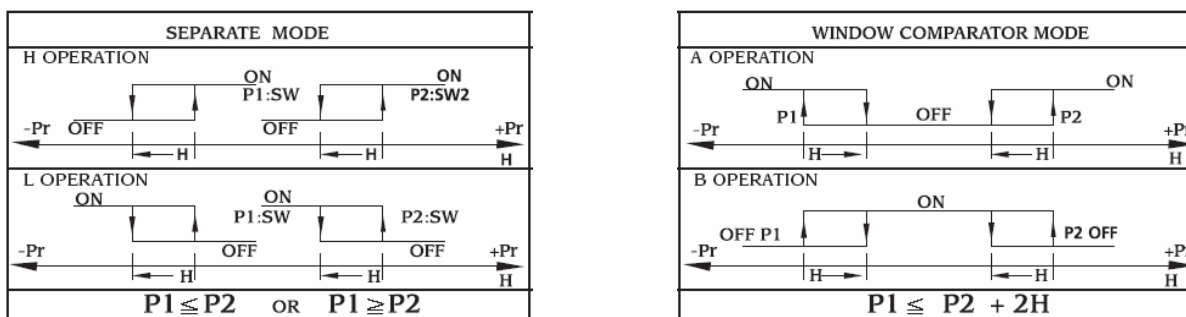

Table 5 – Programmable Output Modes, Table 4 Descriptions for Clarification

Separate Mode ¹		
Mode	Initial SW Outputs	Programmed SW Outputs 1
1	SW1 ON SW2 ON	SW1 OFF when vacuum level reaches set point SW2 OFF when vacuum level reaches set point
2	SW1 ON SW2 OFF	SW1 OFF when vacuum level reaches set point SW2 ON when vacuum level reaches set point
3	SW1 OFF SW2 ON	SW1 ON when vacuum level reaches set point SW2 OFF when vacuum level reaches set point
4	SW1 OFF SW2 OFF	SW1 ON when vacuum level reaches set point SW2 ON when vacuum level reaches set point
Window Comparator Mode ²		
5	SW1 ON SW2 ON	Both SW1 & SW2 shutoff when vacuum reaches setting of SW2 Both SW1 & SW2 turn on when vacuum reaches setting of SW1
6	SW1 ON SW2 OFF	When vacuum reaches the setting of SW2 – SW1 shuts off and SW2 turns on When the vacuum reaches the setting of SW1- SW1 turns on and SW2 shuts off
7	SW1 OFF SW2 ON	When vacuum reaches the setting of SW2 – SW2 shuts off and SW1 turns on When vacuum reaches the setting of SW1 – SW2 turns on and SW1 shuts off
8	SW1 OFF SW2 OFF	Both SW1 & SW2 turn on when vacuum reaches the setting of SW2 Both SW1 & SW2 shutoff when vacuum reaches the setting of SW1
		Note #1: In the Separate mode, setting 1 = SW1, setting 2 = SW2. Note #2: In Window Comparator mode, min. value for SW1 and SW2 corresponds to setting 1 and max. value corresponds to setting 2.

VDS 1000 Setpoint, Hysteresis, and Filter Mode Setup

STEP 1

- Press the up arrow and the mode buttons simultaneously to enter the pressure settings mode.
- The LED under SW1 should be flashing.

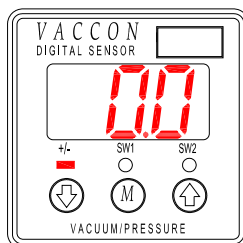

STEP 2 – Setting SW1

- Using the down and up arrows, set SW1 to the desired pressure level.

NOTE: When setting VDS-1000 switch, the LED under +/- is NOT illuminated for positive pressure setting. The LED IS illuminated when setting negative (vacuum) pressure. If the state of the LED needs to be changed, press the down arrow until the LED changes state.

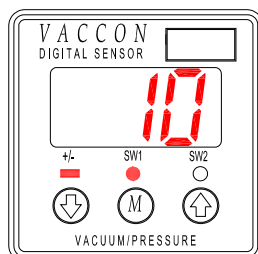

For this example we are setting SW1 to 10”Hg.

- When desired level is set, press the mode button to set SW2.

STEP 3 – Setting SW 2

- The LED under SW2 should be flashing. Using the down and up arrows, set SW2 to desired level.

For this example we are setting SW2 to 20”Hg.

- When desired level is set, press the mode button to set hysteresis.

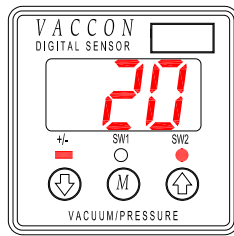

STEP 4 – Setting Hysteresis

- The LED under the +/- should be flashing. Using the down and up arrows, set the hysteresis to the desired level.

Note: The hysteresis setting is for BOTH SW1 and SW2.

- When desired level is set, press the mode button to set digital filtering mode.

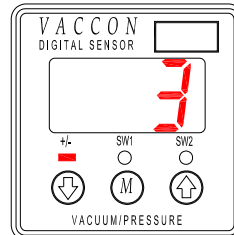

STEP 5 – Setting the Filter Mode

- The filter mode is the sampling rate of the switch. The desired rate is based on the stability of the process.
- Using the down and up arrows, set the filtering mode (SEE TABLE 6).

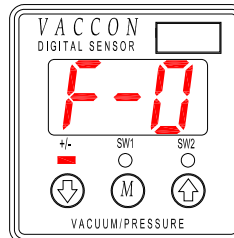
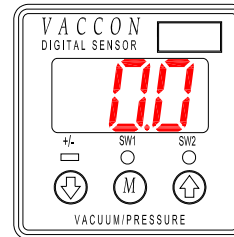

Table 6

Digital Filtering Mode	Response Time
F-0	5 ms
F-1	25 ms
F-2	250 ms
F-3	2.5 seconds

STEP 6

- Once desired setting is selected press the mode button for more than one second to return to the operation mode.





Display Options

The VDS-1000 has three (3) display options that allow the user to temporarily turn off the display, lock the keypad, or completely turn off the display and lock the keypad.



Temporary Mode

- When the keys are not operated for more than 10 seconds during Operation Mode, the system will automatically select Non-Display [Temporary] Mode and the display will turn off.
- Decimal point LED shown in the figure below will blink during Non-Display [Temporary] Mode.
- Using the EEPROM, the VDS-1000 can retain preset values even if the power is turned off.
- If an error message is detected, the display will comeback and show the error message.
- You can change any functions during Non-Display [Temporary] Mode.

Setting the Temporary Mode

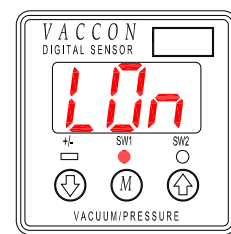
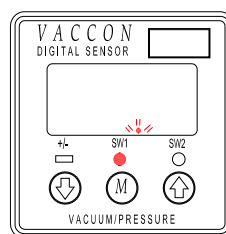
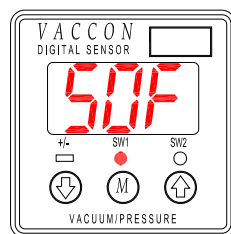
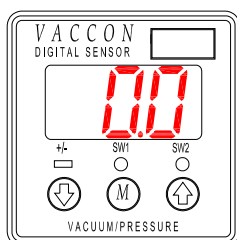
- To enable Non-Display [Temporary] Mode, press  key for more than 4 seconds.  will be displayed and Non-Display [Temporary] Mode will be set. After 10 seconds, display will go off.





- To disable Non-Display [Temporary] Mode, press  key for more than 4 seconds.  will be displayed and Non-Display [Temporary] Mode will be canceled.



Full Time Mode

- In Non-Display [Full-time] Mode, the display will be turned off and the Keys will be locked.
- Decimal point LED shown in the figure below will light up during Non-Display [Full-time] Mode.
- Using the EEPROM, VDS-1000 can retain the preset values even if the power is turned off.
- If an error message is detected, the display will comeback and show the error message.
- You cannot change any functions during Non-Display [Full-time] Mode.

Setting the Full Time Mode

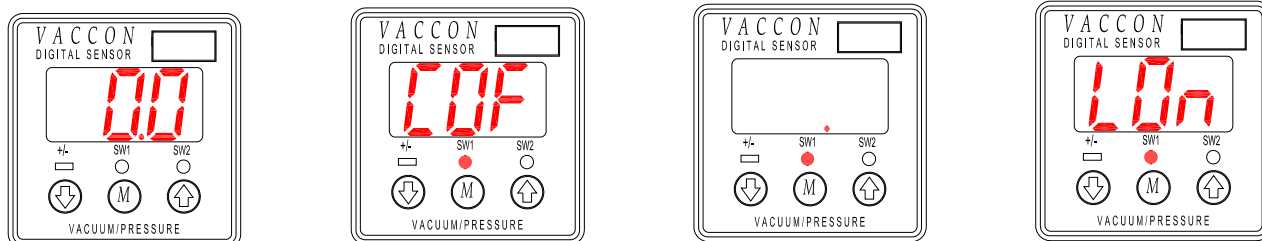
- To enable Non-Display [Full-time] Mode, press  key for more than 4 seconds.  will be displayed and Non-Display [Full-time] Mode will be set. Display will turn off in a second.







- To disable Non-Display [Full-time] Mode, press  key for more than 4 seconds.  will be displayed and Non-Display [Full-time] Mode will be canceled.

Keypad Lock Out Mode

- Key Protection Mode is used to lock the front panel key in order to prevent preset values from being accidentally changed.
- Using EEPROM, the VDS-1000 can retain the preset values even if the power is turned off.

Setting the Keypad Lockout Mode

- To enable Key Protection Mode, press  key for more than 4 seconds.  will be displayed and the keys will be locked.
- To disable Key Protection Mode, press  key for more than 4 seconds.  will be displayed and the keys will be unlocked.

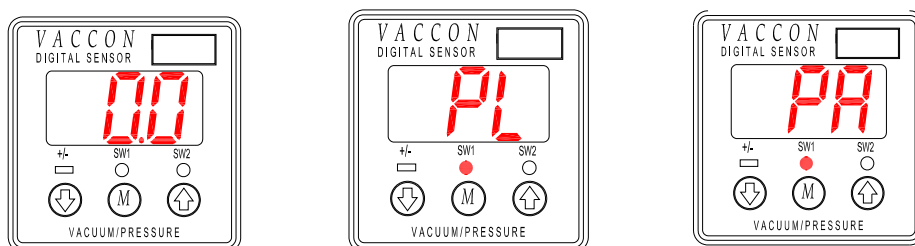

Error Messages

Message	Problem	Solution
E-1	CURRENT OVERLOAD. Flashing L.E.D. indicates overload on SW1 or SW2	Switch off the power. Check the current levels.
E-2	PRESSURE DETECTED when adjusting zero point	Press the "M" button for two (2) seconds to cancel "E-2" display. Remove the pressure source and re-zero the unit.
E-3	INCORRECT SETTINGS. Impossible values for detection have been selected.	Check the settings and reset.
E-4	UNRECOVERABLE FAILURE	Return unit to factory. Review the Vaccon Return Policy first.
---	PRESSURE VALUES EXCEED RANGE	Check applied pressure and settings.
999	PRESSURE VALUES EXCEED RANGE	Check applied pressure and settings.

Alternate Mounting Configurations

Bottom Mount Bracket

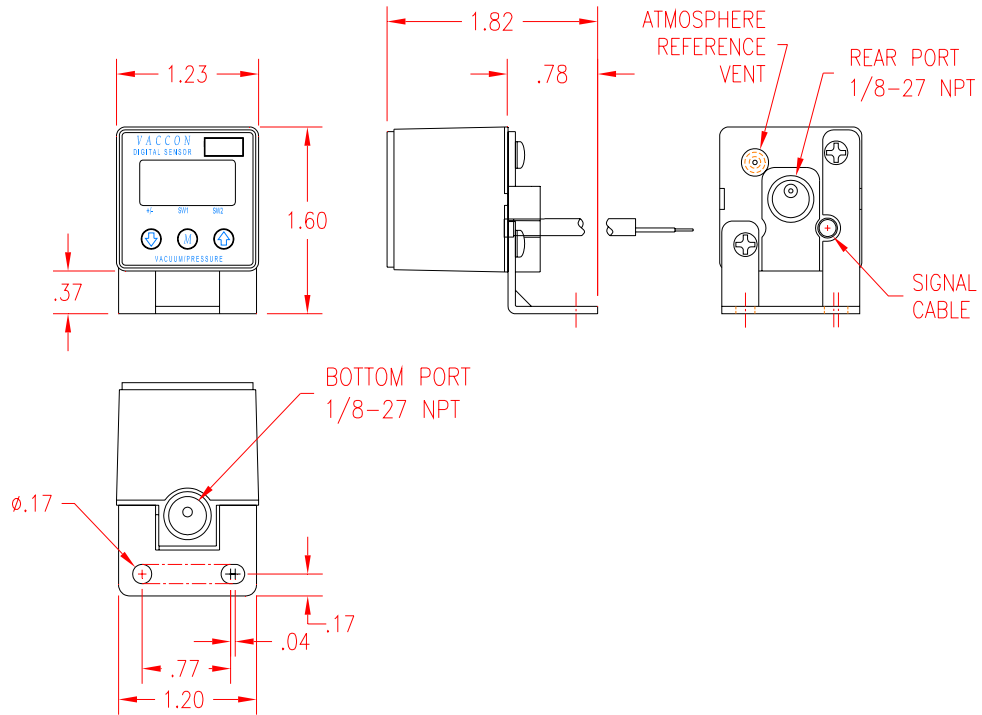

Rear Mount Bracket

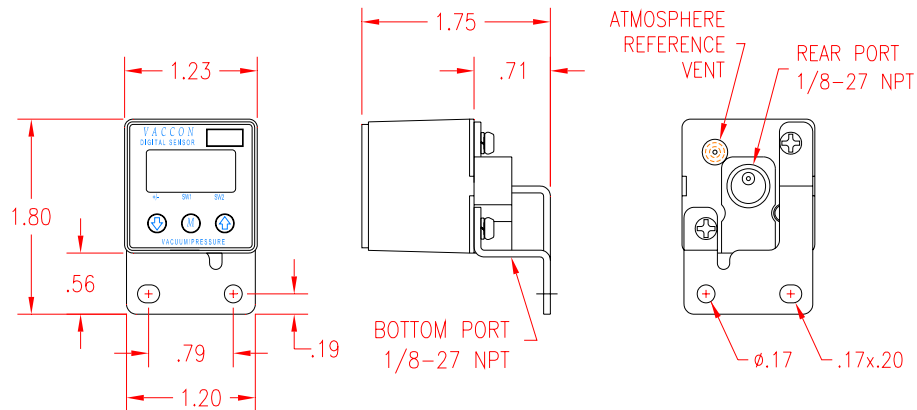

Panel Mount Bracket

