

New! Miniature Plastic Vacuum Generators

I-MPVG Series



Compact I-MPVG Series pumps install easily in tight spaces

Standard Pump:

Vaccon's I-MPVG Series of miniature plastic vacuum generators are economical, compact, lightweight, and offer high performance up to 27.0" Hg [918 mbar].

The I-MPVG-B has a more traditional style with a 90° vacuum port. In-line venturi pumps are virtually the same size as the air supply and vacuum lines allowing installation in the tightest spaces and closest to the point of use for fast response time.

Our single-stage plastic pumps have no moving parts and are dirt tolerant providing reliable, maintenance-free operations.

The I-MPVG-B and I-MPVG-T models contain a built-in silencer. All I-MPVG Series pumps are metric only and have push-to-connect fittings for quick and easy assembly.

Performance Level Designations:

I-MPVG-B models 27.1" Hg [918 mbar] for high vacuum / standard flow applications

I-MPVG-T & I-MPVG-I models 26.8" Hg [908 mbar] for high vacuum / standard flow applications

Pump Options:

- 4 different models (metric thread only)
- Up to 27.1" Hg [918 mbar] vacuum level
- Up to 1.3 SCFM [38 LPM] vacuum flow
- 2 different vacuum flow levels for I-MPVG-B and I-MPVG-I models
- Integral mounting holes (I-MPVG-B and I-MPVG-T models)
- I-MPVG-I-18M vacuum port has G 1/8 threads for installation on End-of-Arm tool or panel mounting

Ideal Applications:

- Pick & Place of small to medium sized parts
- Packaging
- Robotic End-of-Arm Tooling
- Vacuum clamping / holding fixtures
- Vessel evacuation
- Gas sampling for analysis
- Leak testing

Features/Benefits:

- Lightweight and compact for easy point-of-use installation
- Integrated mounting holes
- Built-in silencers
- Push-to-connect fittings [6mm] speed installation
- Fast response – installs close to vacuum point
- Efficient – minimal air consumption
- Safe operation – no electricity needed at the pump
- Reliable – operates trouble-free:
 - ~ No moving parts to wear or clog
 - ~ No flap valves to stick open
 - ~ No maintenance
 - ~ No downtime

Principles of Operation:

Vacuum is produced by forcing compressed air through a limiting orifice (nozzle). As the air exits the orifice it expands, increasing in velocity to supersonic speed before entering the diffuser. This creates a vacuum at the vacuum inlet port located between the nozzle and diffuser. Combined, the nozzle and diffuser create a venturi vacuum cartridge.

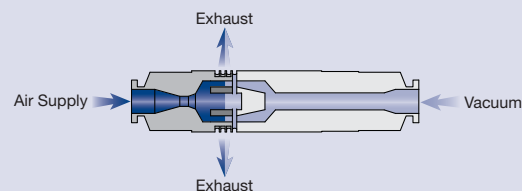

Eliminate the Guesswork: Contact Us!

Vacuum technology isn't an exact science. To ensure proper product selection, Vaccon offers free application engineering assistance, a 30 Day Test & Evaluation Program or you can send sample products to our in-house test facility and we will test and size a pump for you.

To download a complete set of drawings in multiple CAD formats, please visit our website at www.vaccon.com





For more information or technical assistance, please call 508-359-7200 or 800-848-8788 or email engineering@vaccon.com

Miniature Plastic Vacuum Generators

How to Specify:

To order I-MPVG Series pumps, select from the models below. Refer to the performance data chart below to select the desired vacuum flow.

I-MPVG Series Performance Chart

Model #	Air Consumption	Maximum Vacuum	Maximum Vacuum Flow	
	SCFM / LPM	"Hg / mbar	SCFM / LPM	
	I-MPVG-B-55H	0.80 / 22.6	27.1 / 918	0.45 / 12.70
	I-MPVG-B-95H	2.45 / 69.4	27.1 / 918	1.34 / 37.94
	I-MPVG-T-85H	1.60 / 45.3	26.8 / 908	0.99 / 28.00
	I-MPVG-I-35H	0.40 / 11.3	26.8 / 908	0.25 / 7.10
	I-MPVG-I-85H	1.60 / 45.3	26.8 / 908	0.99 / 28.00
	I-MPVG-I-35H-18M	0.40 / 11.3	26.8 / 908	0.25 / 7.10
	I-MPVG-I-85H-18M	1.60 / 45.3	26.8 / 908	0.99 / 28.00

I-MPVG Inline Pump Standard Specifications:

Pump Material:	Nylon body, Nickel plated brass fittings
Medium:	Filtered (50 micron) unlubricated, non-corrosive dry gases
Operating Temperature:	32 to 120 °F [0 to 99 °C]
Operating Pressure:	72 PSI [5.0 bar]

I-MPVG Inline Pump Operating and Installation Requirements:

Supply Line:	6 mm O.D. tubing
Vacuum Line:	6 mm O.D. tubing
Exhaust Line:	8 mm O.D. (I-MPVG-T model only)
Vacuum Line Filtration:	Typically filters are not required; if desired Vaccon recommends – VF125LPM. See page 13.12

Please Note: I-MPVG models are not available for Vaccon's 30 Day Test & Evaluation Program, have no warranty and are not returnable.

I-MPVG-B- (55, 95) (H)



Specifications:

Weight:	<i>I-MPVG-B-55H</i>	0.64 oz [18g]
	<i>I-MPVG-B-95H</i>	1.92 oz [55g]
Noise Level:		74 dB

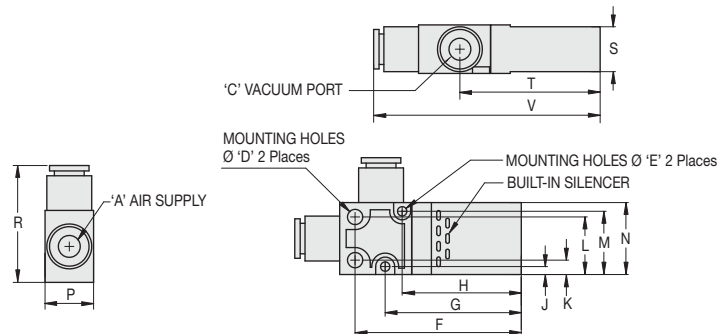

Model #	Imperial Dimensions (in.)																
	A	C	D	E	F	G	H	J	K	L	M	N	P	R	S	T	V
I-MPVG-B-55H	6 mm PTC	6 mm PTC	0.17	0.10	1.82	1.49	1.30	0.09	0.16	0.63	0.69	0.79	0.53	1.28	0.49	1.54	2.48
I-MPVG-B-95H																	
Model #	Metric Dimensions (mm)																
	A	C	D	E	F	G	H	J	K	L	M	N	P	R	S	T	V
I-MPVG-B-55H	6 mm PTC	6 mm PTC	4.0	3.0	46.0	38.0	33.0	2.0	4.0	16.0	18.0	20.0	14.0	33.0	13.0	39.0	63.0
I-MPVG-B-95H																	

Note: Performance Charts represent average performance data. For reference only.

I-MPVG-T-85 (H)

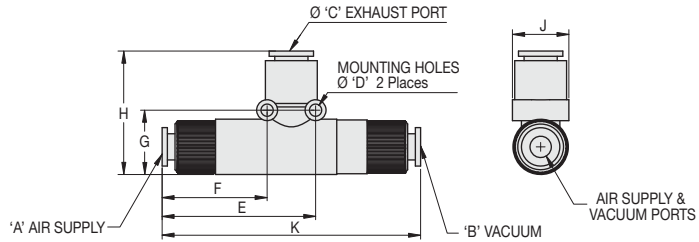

Specifications:

Weight: *I-MPVG-T-85H* 1.52 oz [44g]
Noise Level: N/A: Exhaust is vented

Model #	Imperial Dimensions (in.)									
	A	B	C	D	E	F	G	H	J	K
<i>I-MPVG-T-85H</i>	6 mm PTC	6 mm PTC	8 mm PTC	0.14	1.73	1.18	0.73	1.39	0.59	2.91
Model #	Metric Dimensions (mm)									
	A	B	C	D	E	F	G	H	J	K
<i>I-MPVG-T-85H</i>	6 mm PTC	6 mm PTC	8mm PTC	3.5	43.9	30.1	18.4	35.4	15.0	74.0

I-MPVG-I- (35, 85) (H)

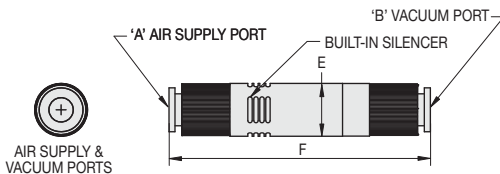

I-MPVG-I

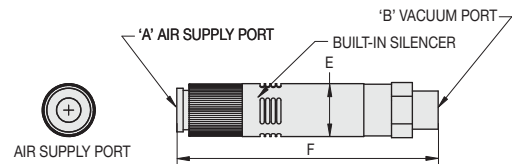

I-MPVG-I-18M

Specifications:

Weight: *I-MPVG-I-35H* 0.88 oz [22g]
I-MPVG-I-85H 1.36 oz [38g]
Noise Level: 74 dB

Model #	Imperial Dimensions (in.)			
	A	B	E	F
<i>I-MPVG-I-35H</i>	6 mm PTC	6 mm PTC	0.52	2.58
<i>I-MPVG-I-85H</i>			0.62	2.91
Model #	Metric Dimensions (mm)			
	A	B	E	F
<i>I-MPVG-I-35H</i>	6 mm PTC	6 mm PTC	13.0	66.0
<i>I-MPVG-I-85H</i>			16.0	74.0

Specifications:

Weight: *I-MPVG-I-35H-18M* 0.88 oz [22g]
I-MPVG-I-85H-18M 1.36 oz [38g]
Noise Level: 74 dB

Model #	Imperial Dimensions (in.)			
	A	B	E	F
<i>I-MPVG-I-35H-18M</i>	6 mm PTC	G 1/8	0.52	2.58
<i>I-MPVG-I-85H-18M</i>			0.62	2.91
Model #	Metric Dimensions (mm)			
	A	B	E	F
<i>I-MPVG-I-35H-18M</i>	6 mm PTC	G 1/8	13.0	66.0
<i>I-MPVG-I-85H-18M</i>			16.0	74.0